

**CHICAGO**  
**Electric**

# BATTERY ISOLATOR

**Model 93801: 70 Amp**

**Model 93802: 90 Amp**

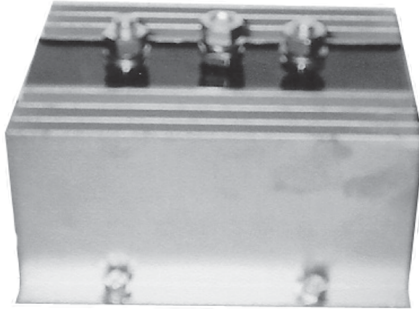

Due to continuing improvements, actual product may differ slightly from the product described herein.



3491 Mission Oaks Blvd., Camarillo, CA 93011

Visit our Web site at: <http://www.harborfreight.com>

**TO PREVENT SERIOUS INJURY,  
READ AND UNDERSTAND ALL WARNINGS  
AND INSTRUCTIONS BEFORE USE.**

Copyright© 2006 by Harbor Freight Tools®. All rights reserved. No portion of this instruction sheet or any artwork contained herein may be reproduced in any shape or form without the express written consent of Harbor Freight Tools.

**For technical questions, please call 1-800-444-3353.**



## **SAVE THIS MANUAL**

You will need this instruction manual for the safety warnings and precautions, assembly, operating, parts list and assembly diagram. Keep your invoice with this instruction manual. Write the invoice number on this instruction manual. Keep this instruction manual and invoice in a safe and dry place for future reference.

## **UNPACKING**

When unpacking, check to make sure all the parts shown in the Parts List (**page 9**) are included. If any parts are missing or broken, please call Harbor Freight Tools at the number shown on this instruction manual as soon as possible.

## SAFETY WARNINGS AND PRECAUTIONS

1.  **WARNING! Avoid risk of fire.** Prior to installation remove the cables from the negative terminals of all the batteries on your vehicle.
2. **Inhalation Hazard!** Do not operate an engine in a closed area or in a poorly ventilated area. **When running, an engine produces carbon monoxide, a colorless, odorless, toxic fume that, when inhaled, can cause serious personal injury or death.**
3. **Prior to installation, make sure to read and understand all instructions and safety precautions as outlined in the engine manufacturer's diagnostic/repair manual.**
4. **Prior to installation, make sure the vehicle's transmission is placed in "PARK" or "NEUTRAL" and the emergency brake is applied.**
5. **Always keep hands, fingers, and body away from the moving parts and hot parts of the engine.**
6. **Dress properly.** Do not wear loose clothing or jewelry as they can be caught up in moving parts. Wear restrictive hair covering to contain long hair.
7. **Do not use this product if under the influence of alcohol or drugs.** Read warning labels if taking prescription medicine to determine if your judgement or reflexes are impaired while taking drugs. If there is any doubt, do not use this product.
8. **Replacement parts and accessories:** This product must be repaired and serviced by a qualified service technician only. When this product is serviced, only identical replacement parts should be used. Use of any other parts will void the warranty. Only use accessories intended for use with this product.
9.  **WARNING!** Avoid eye injury. Make sure to wear ANSI-approved safety impact eye goggles when installing this product, and when working with tools and equipment.
10.  **WARNING!** The warnings and cautions discussed in this instruction manual cannot cover all possible conditions and situations that may occur. It must be understood by the operator that common sense and caution are factors which cannot be built into this product, but must be supplied by the operator.

## REQUIRED TOOLS AND HARDWARE

1. Prior to installation, make sure you have the following tools and hardware (all not included) to complete the installation:

**A.** Phillips screwdriver

**B.** Drill with 1/8" bit

**C.** Wire crimper

**D.** Open end wrench set

**E.** Nut driver set

**F.** Automotive Grade Wire

**G.** Ring Terminals

**H.** Butt Connectors

**I.** Appropriately sized circuit breaker

**J.** Terminal boot covers

## PRODUCT SPECIFICATIONS

Item	Description
Electrical Requirements	Model <b>93801</b> : 70 Alternator Amps Maximum / 6, 12, 24, 32, 48 DC Volts Capable Model <b>93802</b> : 90 Alternator Amps Maximum / 6, 12, 24, 32, 48 DC Volts Capable
Construction	Aluminum Extrusion / Grade 2 Steel Hardware & Fasteners
Dimensions	Model <b>93801</b> : 4-1/2" Wide x 4" Deep At Base x 2-1/2" High (3-1/4" High At Terminals) Model <b>93802</b> : 4-1/2" Wide x 4-15/16" At Base x 2-1/2" High (3-1/4" High At Terminals)
Specifics	Same Nominal Battery Voltage Required for Both Batteries / Negative Grounding Only
Net Weight	Model <b>93801</b> : 1.40 Lbs. / Model <b>93802</b> : 1.70 Lbs.
Features	Multiple Battery Control (Isolates High & Low Charged Batteries) Terminal Hardware Supplied (Fasteners Only/No Wire)
Mounting	4 Slotted Mounting Holes @ 1/4" Diameter

## PRODUCT APPLICATIONS

1. **Make sure to thoroughly review the Applications Chart below prior to installing the Isolator. These Group designations are pertinent when reading all subsequent instructions in this manual.**
2. **NOTE:** All vehicle/part makes and models listed in this manual are registered trademarks (®) of the vehicle/part manufacturers.

<b>GROUP 1</b>	<b>General Motors (Delcotron)</b>	Except Delcotron CS series alternators (CS series used on most 1985 and newer GM vehicles).
	<b>Ford</b>	Up to 1998.
	<b>Chrysler</b>	All models, all years including Nippondenso externally regulated alternators.
	<b>Jeep</b>	Equipped with Nippondenso externally regulated alternators.
	<b>Japanese Imports</b>	With alternators using external voltage regulated or external sensing.
	<b>Motorola</b>	Load Handler Series or 8EM Remote Sensing Series.
	A Group 1 Isolator will have an alternator post and up to four battery posts. There are no colored terminals.	
<b>GROUP 2</b>	<b>General Motors (Delcotron)</b>	Equipped with Delcotron CS Series (most 1985-1993) or CS130-D Series alternators (most 1993 and newer).
	<b>Jeep</b>	Vehicles equipped with Delcotron CS Series alternator (most 1985-1990).
	<b>Toyota, Honda, &amp; Some Imports</b>	1985 and newer equipped with Nippondenso alternator with internal regulators or alternators with an "S" (sense) terminal.
	<b>Ford</b>	Many 1998 and newer.
	Unplugging the plug-in connector from the alternator and counting the number of holes in the connector can identify the CS Series alternator. The CS Series will have three small holes and one large hole. The CS130-D alternator has four pin terminals all the same size. The SI Series will have two slotted holes in the connector. **Delco CS Series alternators require a separate sense wire (not included). <b>All Group 2 Isolators may be used in Group 1 applications.</b> Simply disregard the additional excitation ("E") terminal. A Group 2 Isolator will have a colored fourth terminal indicating the "E" terminal.	
<b>GROUP 3</b>	<b>Motorola</b>	Other than Load Handler Series.
	<b>Bosch</b>	Requiring regulator sensing.
A Group 3 Isolator will have a colored fourth terminal indicating the "R" terminal.		
<b>GROUP 4</b>	Battery Isolators are not compatible with these alternators: A Battery Separator is recommended for these applications. Alternators with internal voltage sensing, i.e., some Mitsubishi and Hitachi, or single wire self-exciting Delco alternators. Isolators may be used if the alternator is modified.	

## GENERAL INSTALLATION INSTRUCTIONS

**PRODUCT USAGE:** The Battery Isolator allows maintenance-free and deep cycle batteries to be properly charged and also offers dual battery control.

1. **IMPORTANT:** If you are installing the Isolator on a Toyota (Alternator Group 2) or a Motorola/Bosch (Alternator Group 3) refer to the special instructions in this manual before disconnecting any part of the existing system.
2. For optimum system performance, use a battery labeled **“Deep Cycle”** in the auxiliary position.
3. Multi-Battery Isolators are designed for alternator systems with negative ground and batteries of the same nominal voltage. **Batteries of differing voltages cannot be used.**
4. Refer to the **“Recommended Wire Size/Circuit Breaker”** Chart below to determine the proper wire size and circuit breaker (not included) for your installation.

MAXIMUM 12 VOLT ALTERNATOR RATING	RECOMMENDED WIRE SIZE/CIRCUIT BREAKER			
	Up to 15 Ft.	15 Ft. to 20 Ft.	20 Ft. to 25 Ft.	25 Ft. to 30 Ft.
70 Amps	#8 Ga./50 Amp	#8 Ga./50 Amp	#6 Ga./50 Amp	#6 Ga./50 Amp
95 Amps	#8 Ga./50 Amp	#6 Ga./50 Amp	#4 Ga./50 Amp	#4 Ga./50 Amp
130 Amps	#6 Ga./80 Amp	#4 Ga./80 Amp	#2 Ga./80 Amp	#1 Ga./80 Amp
160 Amps	#4 Ga./120 Amp	#2 Ga./120 Amp	#2 Ga./120 Amp	#0 Ga./120 Amp
240 Amps	#000 Ga./150 Amp	#000 Ga./150 Amp	#0000 Ga./150 Amp	#0000Ga./150 Amp

5. Remove the cables from the negative terminals of all the batteries on your vehicle.
6. Mount the Isolator in a convenient location as near to the alternator as possible and away from the exhaust manifold. Allow for proper ventilation. Do not mount on the engine. Drill 1/8" holes and mount with the Screws (4) and Split-Lock Washers (5) provided. **(See Assy. Diagram.)**
7. Install the Hex/Speed Nuts (3), Ring Terminal with Wire (not included), Split-Lock Washers (6), and Hex Nuts (2) to the three Isolator Studs as shown in the illustration. **(See Figure A.)**

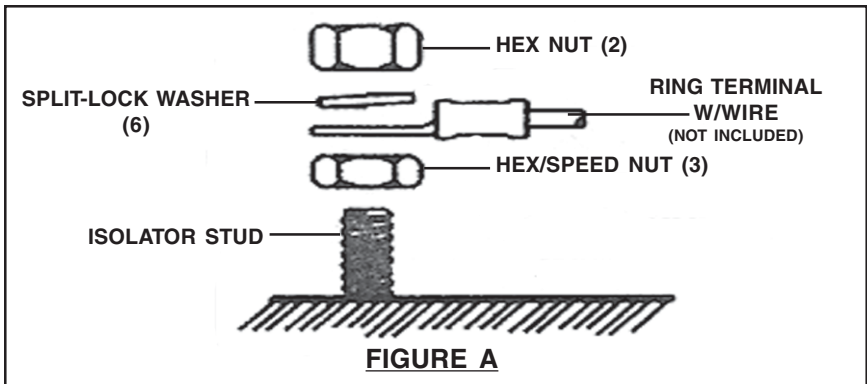

8. Locate the “BAT” terminal at the rear of the alternator. Disconnect ALL the wires (including the voltage regulator sensing wire if present) from the BAT terminal of the alternator. Reconnect these same wires to the #1 terminal of the Isolator. Lengthen the wires if necessary. **NOTE:** Disconnecting or cutting these wires in a location other than at the alternator may result in improper functioning of the charging system. (See Figure B.)

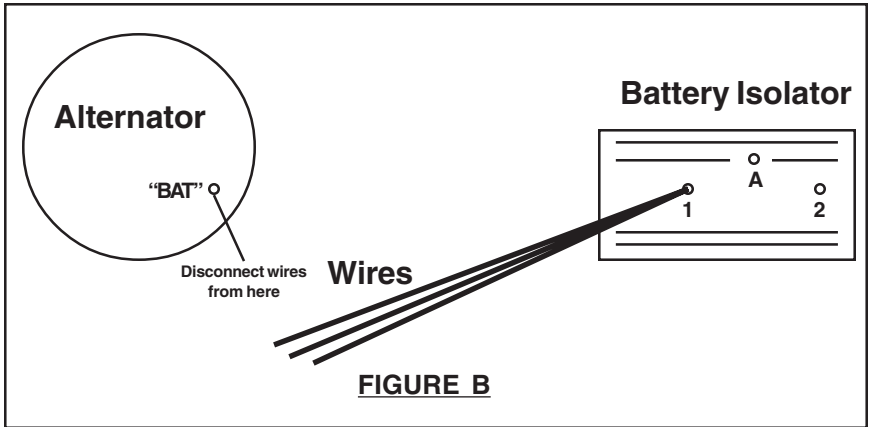

9. Connect one end of a new wire of the proper size (See “Recommended Wire Size Circuit Breaker” Chart) to the battery “BAT” terminal of the alternator and the other end to the “A” terminal of the Isolator. This should now be the only wire connected to either of these terminals. (See Figure C.)

**NOTE:** 1985-1990 Ford or 1998 and newer Ford vehicles may require special instructions (see page 7 for specific instructions).

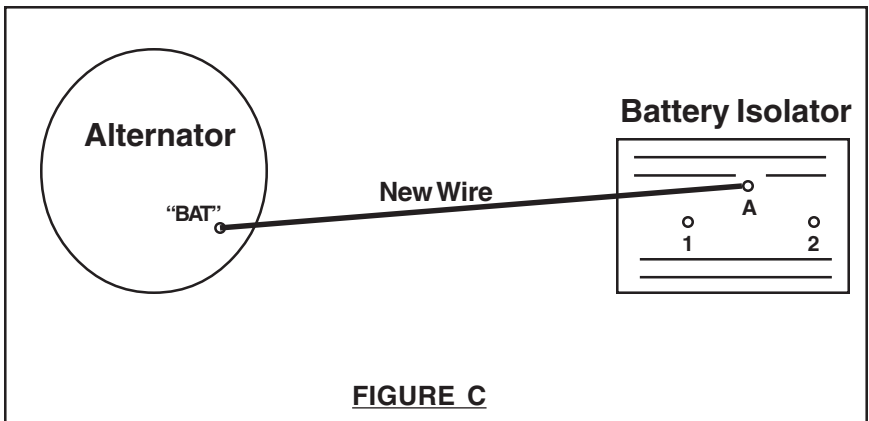

10. Mount a circuit breaker (not included) as near to the auxiliary battery as possible, but away from engine or exhaust heat (See *“Recommended Wire Size/Circuit Breaker”* Chart for proper size). Connect one end of a new wire of the proper size to the “2” terminal of the Isolator. Run the wire to the circuit breaker and connect it to the “AUX” terminal or its equivalent. Run another wire from the circuit breaker to the auxiliary battery, connecting one end to the “BAT” terminal of the circuit breaker and the other to the positive (+) terminal of the auxiliary battery. Repeat for three and four battery isolators. (See Figure D.)

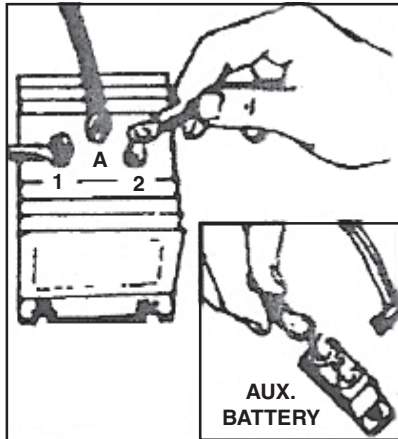

**FIGURE D**

11. Connect all of the auxiliary loads (phone, lights, stereo, refrigerator, winch, etc.) to the positive post of the auxiliary battery(ies). Reconnect the ground cables removed in Step #5. Also, make sure the negative (-) terminal of the auxiliary battery(ies) are properly grounded with a conventional ground strap. Protect with circuit breakers as needed. (See Figure E.)
12. Perform the electrical tests (page 8) to assure proper operation.

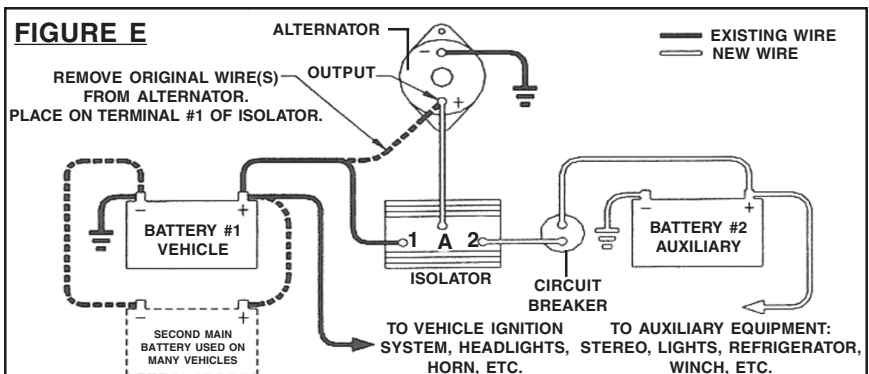

## SPECIAL INSTRUCTIONS FOR FORD INSTALLATIONS (1985 AND LATER)

1. **NOTE:** This section applies to Ford alternators with 2 plug-in connectors. If your alternator has an output bolt, return to Step #10 of the "General Installation Instructions" (page 6).
2. **CAUTION!** Disconnect the battery before proceeding with modification and installation.
3. Locate the connector on the side of the alternator that has one light wire and two heavy black wires with orange or red trace. (See Figure F.)
4. Cut both black/orange wires close to the alternator, allowing enough length to attach a splice (approximately 2-3 inches). Do not cut the smaller wire. Damage to the vehicle may occur if the wires are cut beyond the factory cabling splice (approximately 6 inches from the alternator). (See Figure F.)
5. Splice an extension wire to both wires extending from the vehicle wire harness and connect the other end to the "A" terminal of the Isolator. (See Figure F.)
6. Splice an extension wire to both wires extending from the vehicle wiring harness and connect the other end to the "1" terminal of the Isolator. (See Figure F.)
7. Return to Step #11 of the "General Installation Instructions" (page 6).

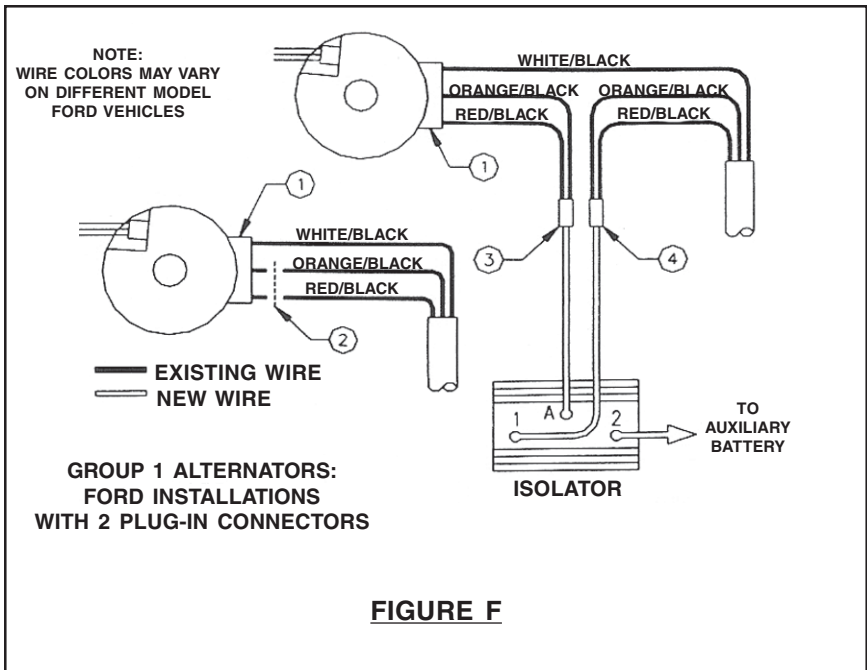

## ELECTRICAL TEST PROCEDURES

1. **NOTE:** Connect the negative test lead to the negative (-) terminal on the battery.

### **Testing With The Engine Not Running:**

The #1 terminal of the Isolator should read vehicle battery voltage. The #2 terminal should read auxiliary battery voltage. The "A" terminal may read from zero to 13 volts.

### **Testing With The Engine Running And Alternator Charging:**

The #1 and #2 should read regulator setting or less, typically from 13.8 to 14.5 volts. The "A" terminal voltage should read 0.8 to 1 volt higher than the reading of the #1 and #2 terminals.

### **Testing For 12 Volt Systems:**

The "A" post should read approximately 14.8 to 15.5 volts. The #1 and #2 terminal should read 13.8 to 14.5 volts. If the "A" terminal reads 13.8 to 14.2 volts the regulator may be sensing the alternator output rather than the main battery. This situation needs to be corrected for proper charging of batteries.

## TESTING THE ISOLATOR WITH AN OHMMETER\*\*

**\*\*If using a digital ohmmeter, a diode scale MUST be used.**

1. Remove all wires from the Isolator.
2. Using a needle movement ohmmeter, Rx-1 scale, or a digital ohmmeter diode scale, hold the RED\* probe on terminal "A" and with the BLACK\* probe touch terminal #1 and #2. A good Isolator will show a current flow from "A" to #1 and #2.
3. Next, hold the BLACK\* probe on terminal "A" and with the RED\* probe touch terminal #1 and #2. A good Isolator will allow no current flow from "A" to #1 and #2.
4. Hold one probe on the aluminum heatsink, making sure there is contact by scratching through the protective coating. Then touch with the other probe terminals "A", #1, and #2. A good Isolator will show no current flow.

**\*NOTE: On some import ohmmeters, the RED and BLACK probes are reversed for these tests.**



## PARTS LIST AND ASSEMBLY DIAGRAM

Part #	Description	Qty.
1	Battery Isolator	1
2	Hex Nut (5/16" x 1-1/4" STD Thread)	3
3	Hex/Speed Nut (5/16" x 1-1/4" STD Thread)	3
4	Hex Head Sheet Metal Screw (#10)	4
5	Split-Lock Washer (1/4" I.D.)	4
6	Split-Lock Washer (5/16" I.D.)	3

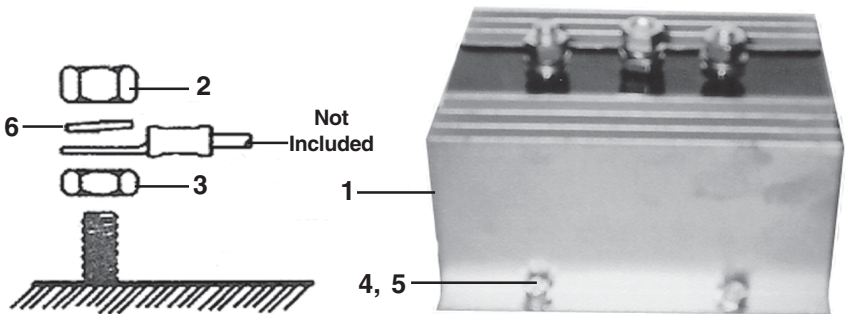

### NOTE:

**Some parts are listed and shown for illustration purposes only, and are not available individually as replacement parts.**

## PLEASE READ THE FOLLOWING CAREFULLY

THE MANUFACTURER AND/OR DISTRIBUTOR HAS PROVIDED THE PARTS LIST AND ASSEMBLY DIAGRAM IN THIS MANUAL AS A REFERENCE TOOL ONLY. NEITHER THE MANUFACTURER OR DISTRIBUTOR MAKES ANY REPRESENTATION OR WARRANTY OF ANY KIND TO THE BUYER THAT HE OR SHE IS QUALIFIED TO REPLACE ANY PARTS OF THE PRODUCT. IN FACT, THE MANUFACTURER AND/OR DISTRIBUTOR EXPRESSLY STATES THAT ALL REPAIRS AND PARTS REPLACEMENTS SHOULD BE UNDERTAKEN BY CERTIFIED AND LICENSED TECHNICIANS, AND NOT BY THE BUYER. THE BUYER ASSUMES ALL RISKS AND LIABILITY ARISING OUT OF HIS OR HER REPAIRS TO THE ORIGINAL PRODUCT OR REPLACEMENT PARTS THERETO, OR ARISING OUT OF HIS OR HER INSTALLATION OF REPLACEMENT PARTS THERETO.